

## G7L-

### Tethered High Altitude Hover Lamp System

## User Manual

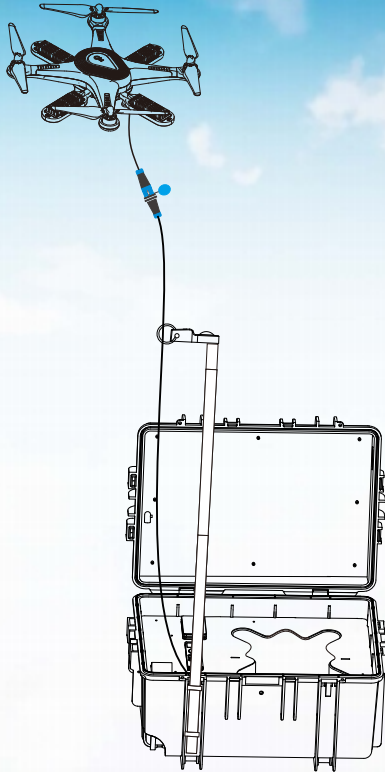

Please read this manual carefully before using the product, and keep it properly

## Preface

- 1、 This user manual introduces the operation instructions,performance parameters,and other related precautions of various components of the GBI's G7L- tethered high altitude hover lamp system.
- 2、 The main advantages of this product in emergency lighting during nighttime are as follows:
  - ① Fast deployment: achieve airborne lighting within 3 minutes after arriving at the scene.
  - ② Lightweight: The total weight of the equipment is less than 26KG,easy to carry.
  - ③ Wide coverage: Illuminate an area of 12000m<sup>2</sup> with a single unit,and multiple units can be stacked infinitely for operations.
  - ④ High brightness: Luminous flux of 120000lm.
  - ⑤ Easy to operate: Using a single-handed hand-held remote controller,no need for professional pilots,and with one-key takeoff and landing function.
  - ⑥ Strong environmental adaptability: operating temperature range from -20°C to 60°C,maximum wind resistance level of 6, maximum rain resistance level of 10,and maximum flight altitude of 4500 meters.
  - ⑦ Low energy consumption: Consume 1.5 kWh of electricity per hour.
- 3、 This manual and all related content,product technology,appearance,etc.are the property of GBI.The company independently produces and sells them.Without written permission,no unit or individual may reproduce,copy,or publish in any form.If cited or published,the source must be identified as "GBI"and the user manual must not be cited,edited,or modified in a way that contradicts its original intent.
- 4、 This version of the user manual is applicable to the G7L- tethered high altitude hover lamp system produced by GBI.

# CONTENT

<b>Safety Precautions And Disclaimer Statement</b>	.....	III
<b>A.System Components And Configuration</b>	.....	P01
I .Overview And Schematic Diagram Of System Components	.....	P01
1.Overview	.....	P01
2.Schematic Diagram Of System Components	.....	P01
II.Main Accessories Diagram And List	.....	P03
<b>B.Operation Of System</b>	.....	P04
I .Preparation Before Operation	.....	P04
II.Specific Introduction And Operation Instructions Of The System	.....	P05
1.Components And Usage Introduction Of Tethered Box	.....	P05
2.Introduction To The Use Of Hand - held Remote Controller	.....	P09

# CONTENT

<b>C.Basic Specifications And Features</b>	-----	P18
I .Basic Specifications	-----	P18
1.Tethered Box	-----	P18
2.Lighting Drone	-----	P18
3.System Power Supply	-----	P18
4.Lighting Fixture Group	-----	P19
II.Functional characteristics	-----	P19
<b>D.After - sales Service, Precautions, And Other Information</b>	-----	P20
I .Declaration Of Hazardous Substances For Electronic Information Products	-----	P20
II.Quality Warranty Statement And Warranty Policy	-----	P20
III.Other Information —— Pre-flight Inspection	-----	P22
IV.Frequently Asked Questions And Simple Answers (FAQ)	-----	P23

## Safety Precautions And Disclaimer Statement

**Before using this lighting drone system, please carefully read the "Safety Precautions And Disclaimer Statement" in this manual.**

### Safety Precautions

Please follow the safety precautions below when using this lighting drone system:

1. Keep away from dangerous environments such as airports, railways, highways, high-rise buildings, power lines, and areas with high electromagnetic interference unless permitted by relevant authorities. Do not use this system in government-designated no-fly zones unless allowed.
2. Place the product in a flat and sparsely populated area and always keep it within the operator's line of sight. If there are spectators nearby, try to keep them away to avoid accidents.
3. Use caution when using this system in adverse weather conditions or environments such as rain, lightning, sandstorms, fog, snow, strong winds, and low temperatures.
4. Keep a safe distance of at least 10 meters between the drone and people or animals during normal low-altitude flight, and stay away from crowds when landing, and avoid water surfaces such as rivers, lakes, etc.
5. Do not use this system near playgrounds to avoid injuries, and do not use it to chase or interfere with vehicles.
6. Ensure that any data, audio, or video material obtained through the use of this product does not infringe on any rights before use.
7. Operators are prohibited to operate the drone while under the influence of alcohol or drugs, or in poor physical or mental condition, such as dizziness, fatigue, nausea, etc. Additionally, it is not allowed to operate the drone when the operator's field of view is backlit, blocked by obstacles, blurry, poor sightedness, etc.
8. Before each use, please check the system, including but not limited to the tightness of components, cracks and wear on the body and propellers, battery levels, and the effectiveness of indicator lights. If abnormalities are discovered, immediately stop using and check, adjust, or replace the corresponding accessories.
9. It is not allowed to forcibly activate the drone for flight if it is in an abnormal state, such as being contaminated with water, oil, soil, sand, or other unknown substances, or if it is not completely assembled. Additionally, if there are obvious failures in the main components or visible defects or missing parts in the accessories, do not attempt to launch the drone.

10. Do not shutdown the drone's motors or "lock" its power source while it is in the air unless it is absolutely necessary.
11. During operation, there are certain risks of high-speed rotating propellers and strong flight power. Therefore, do not attempt to stop any moving parts.
12. Do not modify or replace any parts or components not produced by the manufacturer to avoid causing malfunction to the entire drone and leading to other damages.
13. Failure to assemble or operate the product as guided in the instruction manual may cause accidents and injuries.

### **Disclaimer Statement**

1. This product is not suitable for individuals under the age of 18 and others who do not have full capacity for civil conduct. Please avoid contact with such individuals. If using this product in their presence, please exercise extra caution.
2. To protect the lawful rights and interests of users, please carefully read the "User Manual" provided before using this product. The GBI reserves the right to update the above document. Please follow the "User Manual" to operate and use this lighting drone system.
3. Once you start using this product, it is deemed that you have read, understood, accepted and agreed to all the declaration terms and contents mentioned in the "User Manual" of this product. The user promises to take responsibility for their own actions and all consequences arising therefrom. The user promises to use this product only for legitimate purposes and agrees to this clause as well as any relevant policies or guidelines that may be formulated by the GBI.
4. During the use of this product, it is necessary to strictly comply with and implement the requirements listed in the "User Manual" (including relevant regulations and requirements of the national department for drone products). For any personal injury, accidents, property damage, legal disputes, and other adverse events resulting from violating safety precautions or unforeseeable factors, the user shall bear the related responsibilities and losses, and the GBI shall not assume any liability.
5. The GBI shall not be held liable for any act that violates the legal provisions directly or indirectly caused by the use of this product. The user promises to take responsibility for their own actions and all consequences arising therefrom. The user promises to use this product only for legitimate purposes and agrees to this clause as well as any relevant policies or guidelines that may be formulated by the GBI.

## **A. System Components And Configuration**

### **I. Overview And Schematic Diagram Of System Components**

#### **1. Overview**

This system utilizes drone technology and seamlessly integrates with lighting modules, effectively addressing the long-term mobile lighting challenges in night-time emergency rescue, firefighting, public security, power, agriculture, forestry, highways, bridges, construction, and other industries in complex environments. It has been tested and proven to be powerful and effective. The system uses a 1000W LED light group, which can stay in the air for a long time under continuous power supply, providing uninterrupted and continuous emergency lighting in the air, with high brightness up to 120,000 lumens. This system can be widely used in outdoor activities at night, such as wedding celebrations, camping, commercial and entertainment activities in squares, beach resorts, outdoor bars, etc.

#### **2. Schematic Diagram Of System Components**

The entire system consists of a lighting drone (lighting module + drone platform), a tethered box, etc. The tethered box includes a hand-held remote controller, an automatic cable winding device, a tether cable, and other components, as shown in Figure 1 (see Page 02 for details).

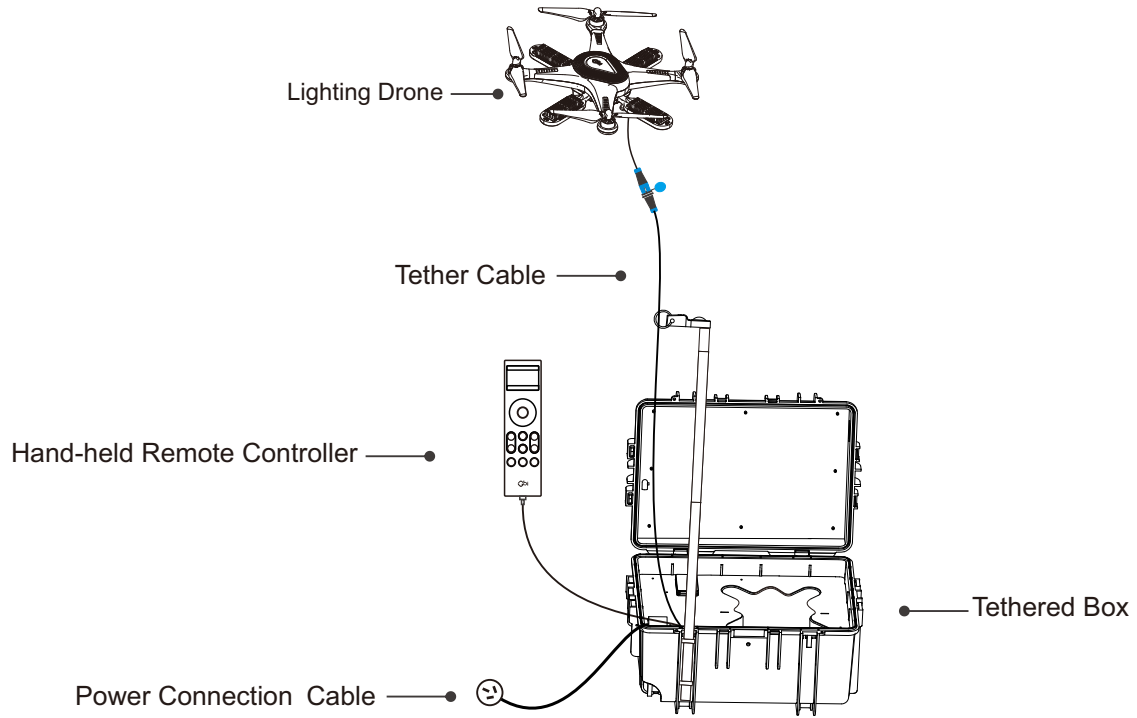
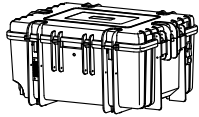

Figure 1:Schematic Diagram Of System Components



## II. Main Accessories Diagram And List



① Tethered Box \* 1

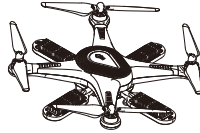

② Lighting Drone\* 1



③ Removable Lifting Pole\*1



④ User Manual \*1



⑤ Warranty Card \*1

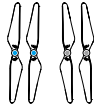

⑥ Propellers \*2  
(Total of 8 pieces)



⑦ Oarlock\*1

## B.Operation Of System

### I.Preparation Before Operation

#### 1.Installation Of Lighting Drone Propellers (Refer To Figure 2)

Install the blue-capped propellers onto the motor mounts without black dots;  
Install the white-capped propellers onto the motor mounts with black dots.

Insert the propeller cap into the motor mount and press it down firmly,  
Rotate the propeller in the locking direction(  )until it cannot be rotated any further.

If the propeller is damaged and needs to be replaced,please use a propeller removal tool to secure the motor, then rotate the propeller in the unlocking direction (  )until the propeller is detached from the motor shaft.

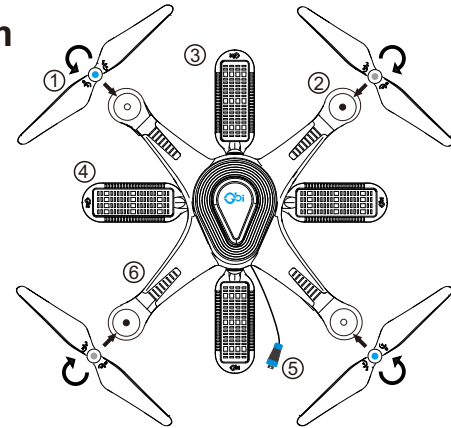

- ① Propellers    ② Motors    ③ Fixed Lighting Set
- ④ Rotatable light set    ⑤ Drone Connector
- ⑥ Aircraft Status Indicators

Figure 2:Schematic diagram of the lighting drone components

#### 2.Connection Sequence Of The Entire System

Insert the lighting drone connector into the tether cable connector and rotate the blue sleeve until it locks into place.



(white dot corresponds to white dot)

#### 3.Power On The System

After the connection is completed, connect the power cable to the utility or generator, when you hear a “beep” sound from the drone and the LED lights blink for a moment and then turn off, it means that the system self-test is normal, wait for the remote control mode to automatically switch to P, then you can use the remote control to operate the lighting drone.

## II. Specific Introduction And Operation Instructions Of The System

### 1. Components And Usage Introduction Of Tethered Box

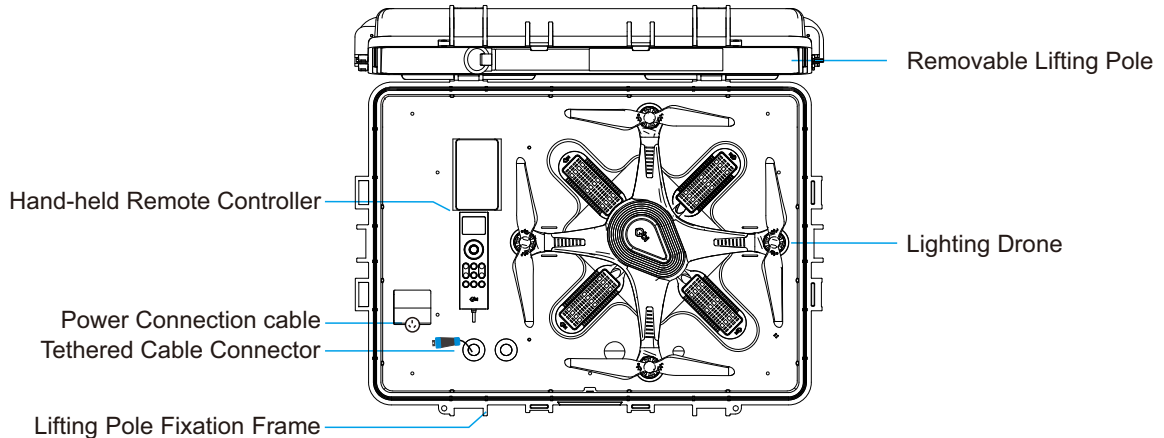

Figure 3: Schematic Diagram Of The Components Of The Tethered Box

#### a. Components Of The Tethered Box System (Refer To Figure 3)

- ① The Tethered Box: It mainly contains lighting drone, automatic retracting device, tethering cable, handheld remote controller, power connecting cable, removable lifting pole, lifting pole fixation Frame and other components.
- ② Automatic retractor: Used for automatic recovery of the tethered cable.
- ③ Tether Cable: Used for providing power to the drone and transmitting signals between the integrated box and the lighting drone.

- ④ Hand-held Remote Controller: Used for controlling the drone and lighting system.
- ⑤ Power Connection Cable: Used to connect the external power supply.
- ⑥ Removable Lifting Pole: Used for restraining the tethering cable.
- ⑦ Lifting Pole Fixation Frame: Used to fix the removable lifting pole.

#### b.Connection and Usage Instructions of Tethered Box System

- ① With the tethered box power turned off (See Page 07,Figure 4-1),connect the mooring cable plug with the drone plug(See Page 07,Figure 4-2),and place it about 5 meters away from the tethered box (**Before taking off the drone,it is essential to fully extend all tether cables outside of the mooring integrated box**).
- ② Connect the external power supplyand, take out the handheld remote control, wait for the drone mode to automatically switch to P mode (Position Mode) before you can control the lighted drone, and fly the drone about 2 meters above the ground (depending on the actual situation).
- ③ Use the hand-held remote controller to operate the drone and fly it to the appropriate position.
- ④ Use the hand-held remote controller to turn on the lighting system of the drone and illuminate the area.
- ⑤ Users can control the “on, off, auto retract” function of the retractor through the rotary retractor switch on the top of the tethered box.

#### Attention:

- ★ **The Tethered Box System cannot be submerged in water,and cannot be exposed to rain or long-term spraying of water from a fire hose.**
- ★ **When unplugging or plugging the connection between the Tethered Box and the Drone,please turn off the power to avoid electric shock accidents.**

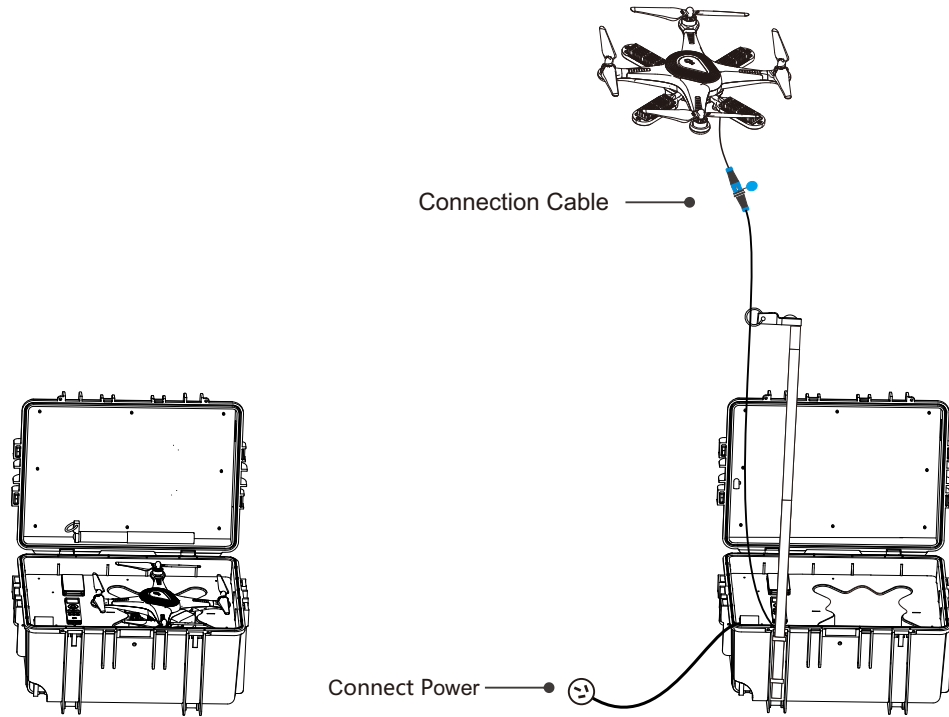
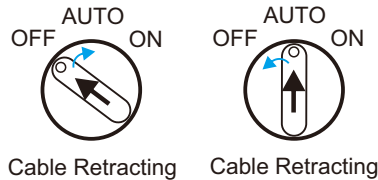

Figure 4-1: Schematic Diagram Of The Initial State Of The System    Figure 4-2: Schematic Diagram Of The Final Connection Of The System

c. Tethered Box System Other Description

- ① To power on or use the mooring integrated box, you need to connect an external power supply.
- ② When the system is disconnected from the external power supply, the backup battery of the tethered box will supply power to the box and the drone, and the buzzer of the case will start to alarm, and the backup battery will stop supplying power after about 5 minutes. (If you need to quickly turn off the backup battery power supply of the tethered Box, you need to rotate the “Cable Retracting” on the tethere Box back and forth within 15 seconds from off to auto for a total of 5 round trips).



d. Determination Of The Flight Direction Of The Drone

- ① The direction of the drone itself (as shown in Figure 5), the rounded blue and white top cover is the nose, and the sharper part is the tail.
- ② When flying at night, the color of the lights on the bottom of the wings can be used to determine the direction of the drone; the side with the red light on is the nose, and the side with the blue light on is the tail.

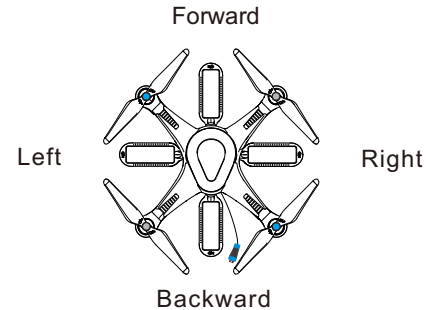

Figure 5: Drone Orientation Diagram

## 2.Introduction To The Use Of Hand-held Remote Controller

### a.The Diagram Of Remote Controller Button Functions (Refer To Figure 6)

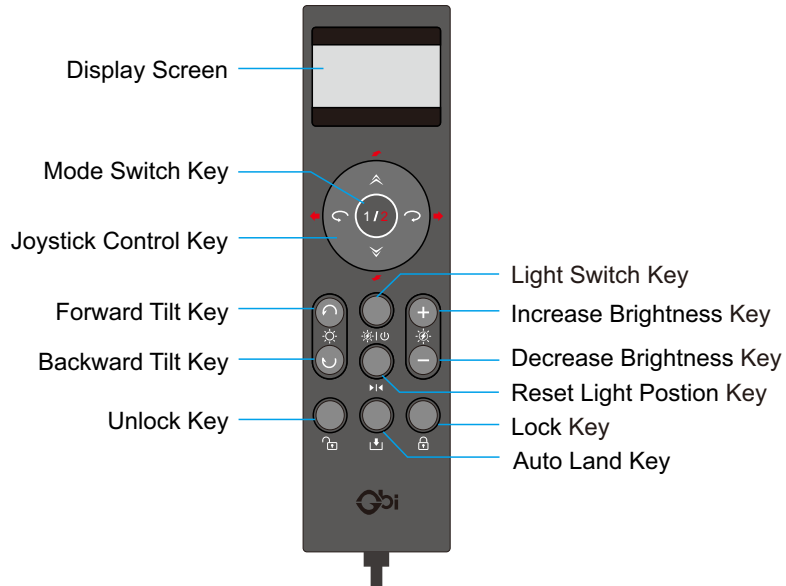

Figure 6:The Diagram Of Remote Controller Button Functions

#### b.Unlock/Lock The Drone With Remote Controller

- Unlock (Power On)The Motors: press the"Unlock"key once,and the motors will start.
- Lock (Power Off)The Motors: press the "Lock"key once,and the motors will stop.(This operation is invalid when the drone is flying in the air).
- Forced Lock: press and hold the "Joystick Key -Down"and the"Lock"key for more than 5 seconds,the motors of the drone will stop in any state (If the drone is in the air at this time,it will crash.Do not operate unless necessary!).

#### c. The Remote Controller (Refer To Page 9,Figure 6)

##### Instructions Before Use

- ① For convenience of use,it is recommended that the back of the drone be aligned with the operator during flight,especially for beginners who are new to using drones.During initial use,it is important to keep the back of the drone aligned with the operator at all times to avoid losing control of the drone.
- ② After the drone is turned on normally,pull the remote controller out of the box,and it will automatically connect to the current drone.
- ③ The drone cannot be operated immediately after starting up.You need to wait for a period of time for the drone to complete self-checking and initialization.
- ④ By default,the remote controller is in Mode 1,which can be switched to Mode 2 by pressing the "Mode Switch"key.There are slight differences in operation between the two modes (See page 14 of this manual for details).
- ⑤ When operating the remote controller,make sure to press only one key at a time and avoid pressing multiple keys simultaneously to prevent operational errors.



### Description Of Functions Of Remote Controller Components

1. Display Screen: Used to display information for remote controller and drone.
2. Joystick Control Key: Linked with "Mode Switch"key,can be divided into two modes:
  - Mode 1:** Ascending,Descending,Turning Left and Turning Right.Blue light is on (Controls the drone's ascending, descending,turning left or right).
  - Mode 2:** Moving Forward,Moving Backward,Moving Left and Moving Right.Red light is on (Controls the drone's movement forward,backward,leftward,and rightward).
3. Mode Switch Key: Switch the function of the "Joystick Control Key".
4. Light Switch Key: Toggle the lights on and off.
5. Forward Tilt Key: Adjust the horizontal light group illumination angle to rotate forward,with a maximum deviation of 90 degrees.
6. Backward Tilt Key: Adjust the horizontal light group illumination angle to rotate backward,with a maximum deviation of 90 degrees.
7. Unlock Key: Press once to unlock the drone.
8. Increase Brightness Key: Holding it will gradually increase the brightness of the lights until they reach the maximum.
9. Decrease Brightness Key: Holding it will gradually decrease the brightness of the lights until they reach the minimum.
10. Reset Light Position Key: set the light groups to their middle initial position.
11. Lock Key: Press once to lock the drone,which is invalid when the drone is in the air.(If you want to force the drone to lock,you need to press and hold the "Joystick Control Key-Down"of the mode button for more than 5 seconds.At this time,the drone will be forced to lock.**If the drone is in the air at this time,it will crash.Please do not perform this operation unless necessary.**)
12. Auto Land Key: Press this button to make the drone in flight automatically descend vertically and land on the ground.

### Main Button Operations And Detailed Explanations

#### (1) Unlock And Lock

The drone can only perform various operations when it is in an unlocked state. The various operations described in this article are based on the assumption that the drone has already been unlocked.

##### ① Unlock

First, make sure the device is working properly and has power. When powered on, the bottom lights of the drone's wings will illuminate. Next, ensure that the drone and remote controller are connected. The connection status can be viewed on the screen (See Figure 7-1). If they are not connected, a cross will be displayed in the lower right corner of the screen (See Figure 7-2). Ensure that all the above conditions are met, and the environment around is safe, then press the "Unlock Key". The drone will turn to the unlocked state with the motors running, and other control operations can be performed.

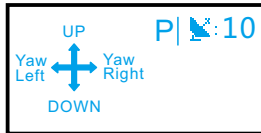

Figure 7-1: Connected status

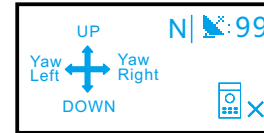

Figure 7-2: Unconnected status

##### ② Lock

Locking will stop the drone's motors. This operation is generally performed when the drone no longer needs to fly.

Under normal circumstances, the drone can only be locked when it is on the ground. Pressing the "Lock Key" while the drone is in the air is invalid. The drone will automatically lock itself after being on the ground for a period of time. If the drone does not lock automatically, you can press the "Lock Key" to lock it manually.

Under special circumstances, if you need to force the drone to lock due to various factors, you need to press and hold the "Joystick Control Key-Down" and the "Lock Key" under the "Mode 1" status for more than 5 seconds. **The drone will be forcibly locked, and if it is in the air at this time, it will crash. Please do not perform this operation unless it is absolutely necessary!**

## (2) Takeoff And Landing

### ① Takeoff

Before taking off, make sure the drone is unlocked and the surrounding environmental conditions are allowed which have been mentioned.

By holding the "Ascend Key", the drone will gradually ascend from the ground. Releasing the button will stop the ascent. You can adjust the altitude of the drone by continuously pressing the "Ascend Key" or "Descend Key" until it reaches the desired position. When the drone is on the ground, it is not allowed to press buttons other than "Ascend Key" because it may cause the drone to move its position.

### ② Landing

When the drone has finished a flight mission, it should be landed first and then locked. Before landing, make sure the ground beneath the drone is flat and free of any other safety hazards.

Landing can be divided into manual landing and automatic landing:

- Manual Landing:

When the drone is in the air, holding the "Descend Key" will cause the drone to gradually lower its altitude until it reaches the ground. When the drone reaches the ground, release the button and then lock it.

- Automatic Landing:

When the drone is in the air, pressing the "Auto Land Key" once will cause it to automatically descend vertically to the ground and lock itself without any other button operations. During this process, if you press any button in the "Joystick Control Key", it will interrupt this behavior and execute a new command. You can use this operation at your discretion when the landing conditions are not ideal. By default, no additional operation is required.

### (3) Basic Controls And Function Switching

The main control of the drone is achieved through the "Joystick Control Key" and "Mode Switch Key", which can be divided into two modes. Pressing the "Mode Switch Key" allows you to switch between the two modes:

#### ① Mode 1:

Ascend, Descend, Turn Left, Turn Right. In this mode, the inner circle lights up in blue and the corresponding text is displayed on the screen, as shown in Figure 8-1.

At this moment, users can control the movement of the drone using the four directions on the "Joystick Control Key".

- By holding down the "UP" key, the drone will gradually ascend in height. Releasing the button will stop this action.
- By holding down the "Down" key, the drone will gradually descend in height. Releasing the button will stop this action.
- By holding down the "Yaw Left" key, the drone will rotate counterclockwise. Releasing the button will stop this action.
- By holding down the "Yaw Right" key, the drone will rotate clockwise. Releasing the button will stop this action.



Figure 8-1: Mode 1

#### ② Mode 2:

Forward, Backward, Left, Right. In this mode, the inner circle lights up in red and the corresponding text is displayed on the screen, as shown in Figure 8-2.

At this moment, users can control the movement of the drone using the four directions on the "Joystick Control Key".

- By holding down the "Forward" key, the drone will gradually move forward. Releasing the button will stop the movement.
- By holding down the "Backward" key, the drone will gradually move backward. Releasing the button will stop the movement.
- By holding down the "Left" key, the drone will gradually move left. Releasing the button will stop the movement.
- By holding down the "Right" key, the drone will gradually move right. Releasing the button will stop the movement.



Figure 8-2: Mode 2

#### (4) Control Of The Lighting Group

The main function of the lighting group is controlled by the six buttons in the middle (Refer To Figure 9).

The lighting group on the horizontal axis (perpendicular to the front and back direction of the drone) can be rotated.

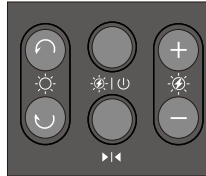

Figure 9:Lighting Group Control button

##### ① Light ON/OFF

Press the "Turn on/off"key once to toggle the on,blinking and off state of the lighting group.

##### ② Illumination Direction

- Hold down the "Forward Tilt Key" of the lighting group,and the illumination direction of the lighting group on the horizontal axis will gradually turn forward.The maximum rotation angle is 90 degrees.
- Hold down the "Backward Tilt Key" of the lighting group,and the illumination direction of the lighting group on the horizontal axis will gradually turn backward.The maximum rotation angle is 90 degrees.
- Press the "Reset Light Position Key" of the lighting group once,and the illumination direction of the lighting group on the horizontal axis will return to the center initial position,which is vertical downward illumination.

##### ③ Illumination Brightness

- Hold down the "Increase Brightness Key" ,and the brightness of the lighting group will gradually increase until it reaches its maximum value.
- Hold down the "Reduce Brightness Key" ,and the brightness of the lighting group will gradually decrease until it reaches its minimum value.

### (5) Screen Display

The screen of the remote controller will display some of the status of the drone and the remote controller.

① The left joystick displays the functional mode of the remote controller

- Under Mode 1 (See Figure 10-1), the drone can execute commands for ascent, descent, left turn, and right turn.
- Under Mode 2 (See Figure 10-2), the drone can execute commands for forward, backward, left, and right movement.

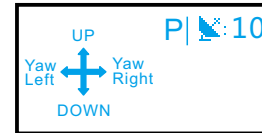

Figure 10-1: Mode 1

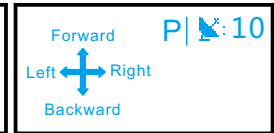

Figure 10-2: Mode 2

② In the upper right corner, it displays the current mode and GNSS signal of the drone (Refer To Figure 10-3).

The letter represents the current flight mode of the drone, and the gear is automatically switched by the drone. It can be divided into "N", "P", "A", "H", "L" and so on.

- N : The drone is not ready or disconnected.
- P : Positioning mode (When the GNSS module connects to the minimum required number of satellites, it will automatically switches, It can achieve accurate hovering in the air)
- A : Attitude mode
- H : Loiter mode
- L : Landing mode

The number on the right of the radar icon (📶) represents the strength of the GNSS signal received by the drone, The larger the number, the stronger the signal.

③ The connection status between the remote controller and the drone is displayed in the bottom right corner.

- If there is no display in the bottom right corner (See Figure 10-3), it indicates that everything is normal and you can operate the drone.
- If the drone is not connected, it will display as shown in Figure 10-4, and operation will not be possible at this time.
- If it is displayed as shown in Figure 10-5, the drone is in sleep mode, you need to wake up the remote controller before you can operate it.

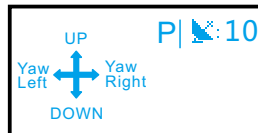

Figure 10-3: Normal

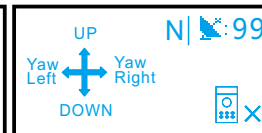

Figure 10-4: Unconnected

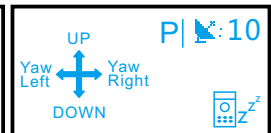

Figure 10-5: Hibernate

## (6) Other Operations

### Sleep And Wake-up

- When the remote controller is not operated for a long time (more than 15 minutes),it will automatically turn into sleep mode (the screen displays as shown in Figure 11-1),and you cannot directly control the drone.The drone will remain hovering.
- When the remote controller is in sleep mode,press and hold the "Mode Switch Key"for 1.5 seconds to wake up the remote controller.The screen will display as shown in Figure 11-2,and you can then perform other operations normally.

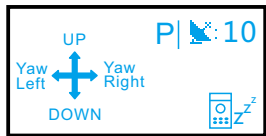

Figure 11-1:Remote Controller Sleep Mode

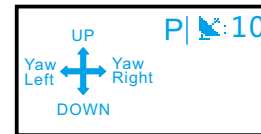

Figure 11-2: Remote Controller Wake-up Mode

## C.Basic Specifications And Features

### I .Basic Specifications

#### 1. Tethered Box

- Cable Length: About 20m
- Size: About 640x490x335mm
- Weight: About 26kg (including drone and other accessories)
- Battery Capacity: 44.4V/2600mAh/155.4Wh

#### 2. Lighting Drone

- Connection Mode: Wired Control
- Control Mode: Hand-held Remote Controller
- Weight: About 1kg
- Wind Resistance Level: Class 6
- Dimensions: About 405x405x118mm
- Maximum Flight Altitude: 20m
- Wheelbase: 350mm

#### 3. System Power Supply

- Input Voltage: AC 220V $\pm$ 10% 10A 50/60HZ
- Rated Power: 1300W (Turn On The Light)/  
300W (Turn Off The Light)



#### 4. Lighting Fixture Group

- Rated Power: About 1000W
- Luminous Flux: About 120000lm
- Illumination Range: The coverage area is about 12000m<sup>2</sup>
- Rotation Control Angle: -90°~+90°
- Normal Operating Temperature: -20°C~ +60°C

## II. Features

Convenient To Carry	The entire system is designed to be lightweight, with a total weight of less than 26KG
Quick To Deploy	The system can be launched and provide long-lasting illumination within 3 minutes of arriving on site
Wide Illumination Coverage	In single-machine mode, the system can illuminate an area of approximately 12000m <sup>2</sup> . In multi-machine operation mode, the coverage can be infinitely increased by stacking the machines
Low Power Consumption	Consume 1.5 kWh of electricity per hour
Intelligent, Safe, and Easy to maintain	The system can be remotely controlled with one hand and features one-button takeoff and landing, as well as lightweight and intelligent design that requires no professional maintenance

Table 1

## D.After-sales Service,Precautions,And Other Information

### I .Declaration Of Hazardous Substances For Electronic Information Products

Component Name	Toxic and Harmful Substances or Elements					
	Pb	Hg	Cd	Cr6+	PBB	PBDE
Plastic shell	○	○	○	○	○	○
Metal Components	X	○	○	○	○	○
PCBA	○	○	○	○	○	○
Electric Wire	○	○	○	○	○	○
LED	○	○	○	○	○	○
Battery	X	○	○	○	○	○

Table 2

○ : This indicates that the content of hazardous substances in all homogeneous materials of the component is below the limit requirements specified in SJ/T 11363-2006'Requirements for Concentration Limits of Hazardous Substances in Electronic Information Products'.

X : This indicates that the content of hazardous substances in at least one homogeneous material of the component exceeds the limit requirements as specified in SJ/T 11363-2006. Components containing hazardous substances or elements cannot be replaced due to limitations imposed by global technological development.

### II.Quality Warranty Statement And Warranty Policy

This drone lighting system(product)can be refunded or exchanged within 7 days from the date of purchase if a malfunction occurs during normal use.Consumers who purchase products from our company can enjoy free repair services for non-human-induced malfunctions within one year.For consumers who do not qualify for free replacement or repair services (Refer To Table 3),our company still provides technical services and only charges material fees when parts need to be replaced during maintenance.The purchase timeshall be based on the date of the invoice or receipt issued by the distributor.

■ **Consumers cannot enjoy the "Three Guarantees Service" in the following situations**

1. Damage or malfunction caused by human factors, use in abnormal working environments, or use not in accordance with the instructions or environmental conditions specified in the instructions.
2. Disassembly, repair, or modification of the product without the consent of our company by the user.
3. Damage caused by other irresistible forces (such as floods, lightning strikes, earthquakes, or abnormal voltage).
4. Products that do not belong to our company (such as counterfeit goods).
5. Inability to provide a valid purchase voucher or warranty card.
6. Expiration of the three guarantees period.

■ **Free repair services (not limited to the issues listed below, other issues that have been officially diagnosed can also enjoy free repair services), please refer to Table 3 for details.**

Number	Warranty content
1	The drone cannot function properly
2	The lighting system cannot be turned on properly
3	The hand-held remote controller is not functioning properly
4	The tethered box system is not functioning properly
5	Obvious manufacturing defects were found in the product without prior use

Table 3

- **The warranty period for major components is valid for 3 years (please refer to the contract for specific terms), see Table 4 for details.**

Component Name	Warranty Coverage	Three Guarantees Period
Drone Circuit	Circuit Components	12 Months
Drone Body	Drone Body,Propellers,Light Covers	No Warranty
Lighting Fixture Group		6 Months
Motor		6 Months
Hand-held Remote Controller		6 Months
Tethered Box		6 Months

Table 4

### III.Other Information — Pre-flight Inspection

- 1.Check whether the drone body,propellers,illumination light set,and other components or external structures are intact and without safety hazards.
- 2.Turn on the power and press the light switch to see if it can be turned on and off normally.
- 3.Check whether the propellers are installed correctly and tightened,and whether the cable connectors are properly installed.
- 4.Check whether the drone is in hazardous environments such as airports,railways,power lines,and high electromagnetic interference areas such as mobile base stations and high-power transmission equipment.
- 5.When working in the field or in rainy weather,pay attention to waterproofing.The integrated box is strictly forbidden to enter water.
- 6.Do not use the drone in severe weather conditions such as thunderstorms and lightning.

## IV.Frequently Asked Questions And Simple Answers (FAQ)

1.The drone cannot be immediately unlocked and take off after being powered on.

Please move the equipment to an open outdoor space,wait for the radar signal on the hand-held remote control display to show 10 or higher,and then try to unlock the drone using the remote control.

2.The cable system cannot be retracted.

Please confirm that the "automatic retraction"of the box is turned on.At this time,the blue light of the cable system switch will be on.If it is not lit,please press this button to turn on the automatic retraction function.

3.The drone cannot hover autonomously after takeoff.

Check for strong magnetic field interference in the surrounding area.

4.During drone operation,the drone flies in the opposite direction.

Press the "Forward Tilt Key"or "Backward Tilt Key"on the remote control to adjust the drone until the tail is facing the operator.

# Creating Value Through Innovation Serving Society With Love

## **ZHEJIANG GBI INTELLIGENT EQUIPMENT INC.**

(The product has passed the product inspection of Zhejiang Electronic Information Product Inspection Institute)

---

Address: No. 268, Meilin Road, Qixian Street, KeQiao, ShaoXing, Zhejiang Province, China  
Telephone: +86-15857541933

Website: <http://en.gbdrone.com>  
WeChat Official Account: hiyegbi